

ARGON RF PLASMA TREATMENT OF PET FILMS FOR SILICON FILMS ADHESION IMPROVEMENT

I. A. Rusu*, G. Popa, S. O. Saied^a, J. L. Sullivan^a

Plasma Physics Department, A.I. Cuza University, Iasi-700506, Romania

^aSurface Science Research Group, EEAP, Aston University, Birmingham B4 7ET, UK

The main aim of this studies was to find the most effective methods to improve the adhesion between thin silicon films and polymer surfaces. The PET films surface modifications induced by treatments in argon rf discharge were investigated using XPS analysis, contact angle method and AFM analysis. An rf magnetron system was used to deposit the thin Si layer on PET samples. The peel-load test offered quantitative information related to the adhesion between silicon layer and polymer surfaces.

(Received January 12, 2005; accepted September 22, 2005)

Keywords: RF plasma, PET films, Silicon film, Adhesion

1. Introduction

The plasma surface interaction involves processes which can be used for polymer surface treatment in order to modify their surface energy, optical reflection, permeability, surface conductivity, biocompatibility and adhesion to other materials, etc. Recently, plasma techniques have also been used for the adhesion improvement of biomolecules to polymer membranes for biotechnological applications. The most important feature of the plasma technique is that the surface properties of the treated material can be modified without changing their intrinsic bulk properties.

Plasma treatments can improve the adhesion in the polymer-coating interfaces by increasing one or several of the following phenomena: cleaning by ablation of low molecular weight species, dehydrogenation, chain-scissioning combined with cross-linking, generation or incorporation of radicals and reactive species and structural modifications of the surface topography. A good macroscopic adhesion between polymer and coating material depends not only on the characteristics of the interface, but rather on the whole interphase region, namely on the successive layers joining the bulk phase of the overcoat. Therefore, a good plasma treatment has to ensure suitable conditions for adhesion without involving degradation of the near surface region, i.e. the optimal adhesion strength is limited by the smallest intrinsic cohesion strength of the bulk and the surface region of the polymer.

Many investigations have shown that ions are the most efficient species in the plasma to modify polymer surface [1]. Since the penetration depth of low energy ions in a solid is extremely small, ions seem to be very important for the modifications in the first few nanometers of the polymer surface during plasma treatment. The kinetic energy of the ions hitting the sample surface is given by their energy in plasma and by energy obtained within the ion sheath which support the difference between the plasma potential and the floating potential of the sample.

The main aim of these studies was to find the most effective methods to improve the adhesion between thin silicon films and polymer surfaces.

2. Experimental

Low pressure plasma used for surface modification was produced in an asymmetric industrial OPT (Oxford Plasma Technology) Plasmalab 100 capacitively coupled system with the

* Corresponding author: iorusu@uaic.ro

grounded electrode (including the chamber walls) area much larger than the driven electrode [2]. A matching network was used to match the impedance in order to maximise the energy transfer from the rf power supply to the plasma. (Fig. 1). The pressure was kept constant automatically by measuring the pressure via a capacitive manometer (CM) gauge and a pumping throttle valve.

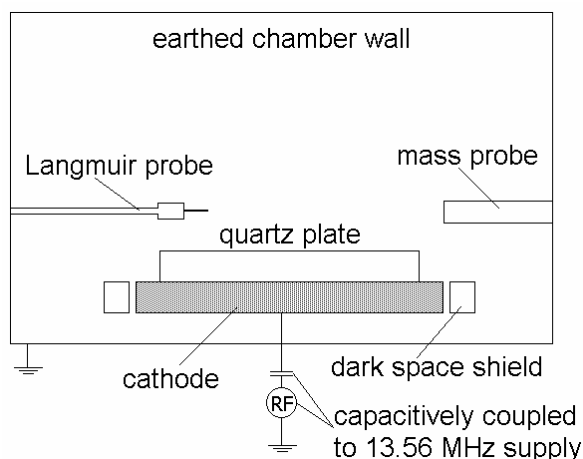

Fig. 1. Experimental set-up.

The polymer samples Good fellow 200 μ foils, were cut into 8 \times 8 mm, ultrasonically cleaned in alcohol to remove organic material and dried with hot air before the treatment. In our investigations, the polymer used was PET (Polyethylene terephthalate) provided by Goodfellow Company.

Argon of 99.095 % was used without further purification. No effort was made to dry the gas, because of the amount of residual water adsorbed on the surfaces of the reactor vessel, which could not be readily removed. The reactor was flooded with argon to a pressure of 1 Torr, for 5 min. prior to plasma treatment. Typical treatment parameters were: Ar gas pressure between 10 mTorr and 90 mTorr, rf power between 10 and 150 W, gas flow rate 10 sccm, treatment times between 1 min and 30 min.

XPS and contact angle measurements were employed to characterise polymer surface modifications.

XPS was performed in a VG ESCALAB 200D spectrometer with MgK α X-ray radiation. The binding energy is determined by setting the aromatic carbon at 284.7 eV and shifting the complete spectrum accordingly. This is necessary due to charging of the non-conducting polymer samples. The XPS peaks were analysed by means of a computer program incorporated in the VG Eclipse data system. Concentration of elements was evaluated from peak area after Shirley background subtraction using the theoretical cross sections [3]. The XPS investigations were realised at 70 $^\circ$ take-off angle measured with respect to the sample normal. If the mean free path (λ) for the C 1s electrons is taken approximately 14 \AA , the sampling depth ($3\lambda\cos\theta$, where θ is the take-off angle) 70 $^\circ$ is found to be 14.3 \AA .

A contact angle meter measured the contact angle in sessile drop method. Each value of the contact angles was taken as an average value measured from five different samples fabricated under the same experimental conditions. Surface free energy, i.e. the sum of the polar force and the dispersion force, was calculated by measuring the contact angles of two different polar liquids (water and formamide) on polymer surface. From the measured contact angles, the polar force and the dispersion force were calculated using the Owen method [3].

AFM (Topometrix Instrument) was employed to measure the surface morphology of the modified/deposited samples. The Si layer was deposited on the untreated and modified polymer surface by magnetron sputtering.

The adhesion between Si layer and the modified polymers was measured by peel-load test. The load test was realised using super glue and aluminium foil. The aluminium foil was peeled off at

90°. The maximum force used was about 40N. A limitation of the peel test is the introduction of third body, the adhesive backing, in the system, which sometimes complicates the determination of absolute value of coating adhesion.

3. Results and discussion

The C1s spectrum for the untreated PET consists of three peaks (without the peak due to π^* shake up transition), close to those presented in the literature [4,5]: the carbon atoms from the benzene ring C₁ (284.24 eV), the methylene carbon single bonded to oxygen C₂ (285.83 eV) and the ester carbon atoms C₃ (288.23 eV). Two peaks, due to carbonyl O₁ (O=C, 531.30 eV) and ester O₂ (O-C, 532.87 eV) oxygen atoms stand out in the O1s spectrum of the untreated PET. Resolved peak areas do not agree with the calculated ratio 3:1:1, the content in carbon double bonded to oxygen C₃. This behaviour can be explained knowing that in paracrystalline structure, like in PET foils, spaces between crystallites are completed with an amorphous phase which is determined by the chaotically and inhomogeneous distribution of the CH₂ groups. The difference of almost 5% in the intensities for O₁ and O₂ in the virgin PET could be due to the presence of some residual monomer or to the cyclic oligomers.

The results from the quantitative analysis of the XPS spectra showed a content of 70.2% C and 29.8% O. The C:O ratio of the untreated polymer is in a good agreement with the theoretical composition of PET: sum formula (C₁₀H₈O₄)_n yields 71.4% C and 28.6% O.

From the XPS data after PET surface treatment, the O1s/C1s, O-C/C and O=C/C ratios were obtained and they are presented in Figs. 2-6 vs rf power values and treatment time.

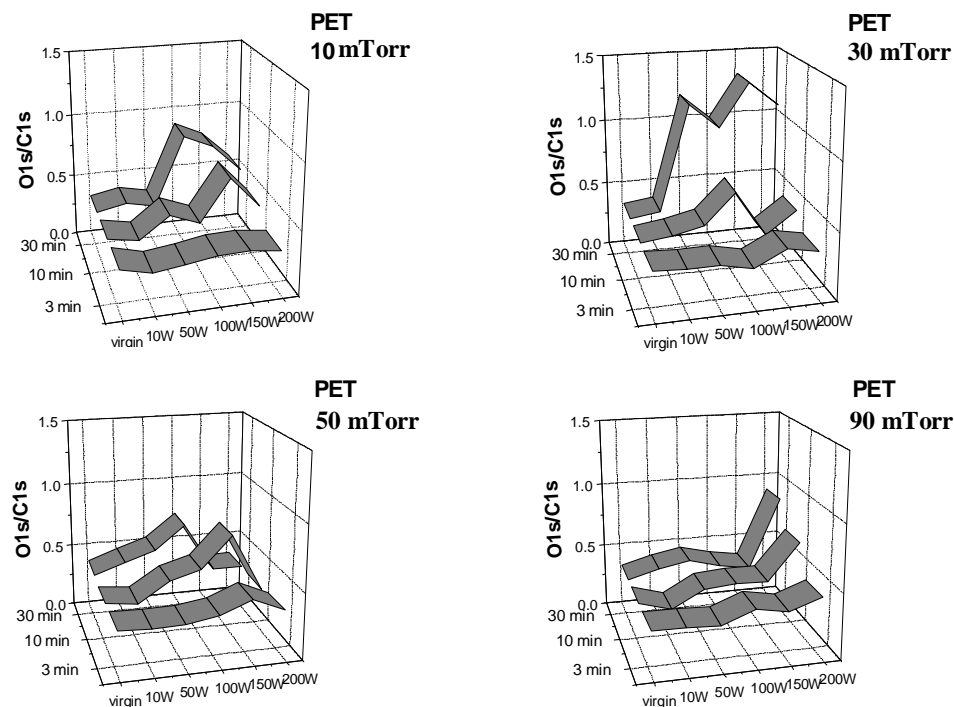

Fig. 2. The O1s/C1s ratios after different plasma treatment conditions and different treatment times.

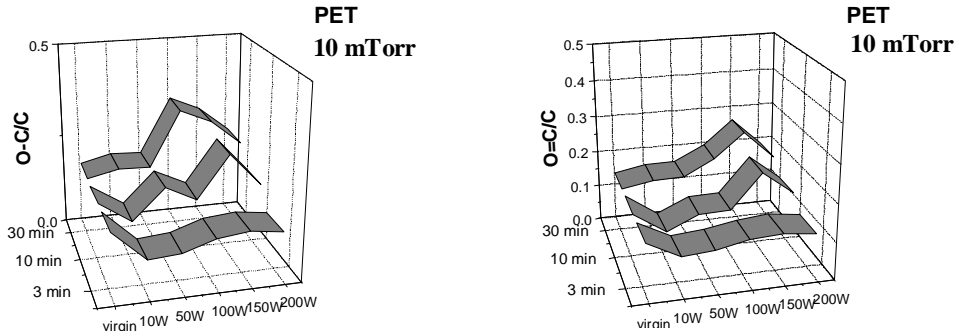

Fig. 3. The O-C/C and O=C/C ratios after plasma treatment at 10 mtorr.

The O1s/C1s ratio is greater than in untreated PET for all treated samples. This increase is due to the increase in O=C/C ratio, but mainly to the increase of O-C/C ratio, especially at low pressures: 10 and 30 mtorr. These aspects suggest an etching process in stationary regime.

It is shown that at higher ion doses (high power and long treatment time) can appear a chain scission with the elimination of the O-ArC=O groups [5,6]. The most active elements from the system which can lead to the chain scission are the ion bombardment, UV radiation and the atomic Ar bombardment.

The scission of the polymers due to the plasma ion bombardments determines the appearance of microdomains with low molecular weight, especially at the limit of the ion penetration depth. The dimension of the polymer chain which serves as primary nucleus is a critical one, since only such a nucleus is expected to be able to redissolve and reform repeatedly; shorter chains than this are redissolved.

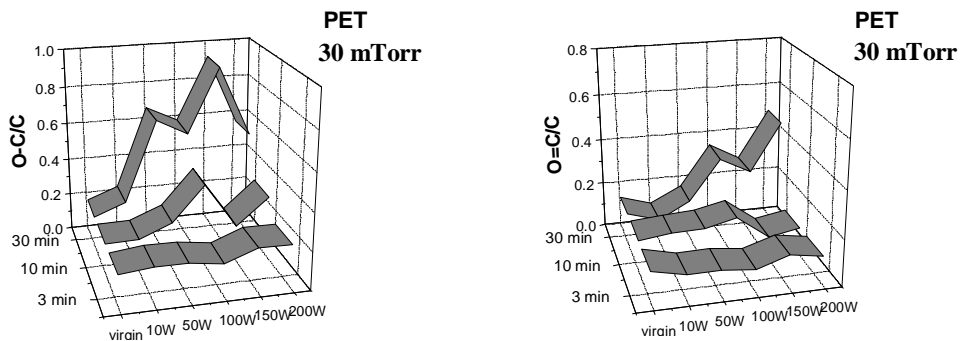

Fig. 4. The O-C/C and O=C/C ratios after plasma treatment at 30 mtorr.

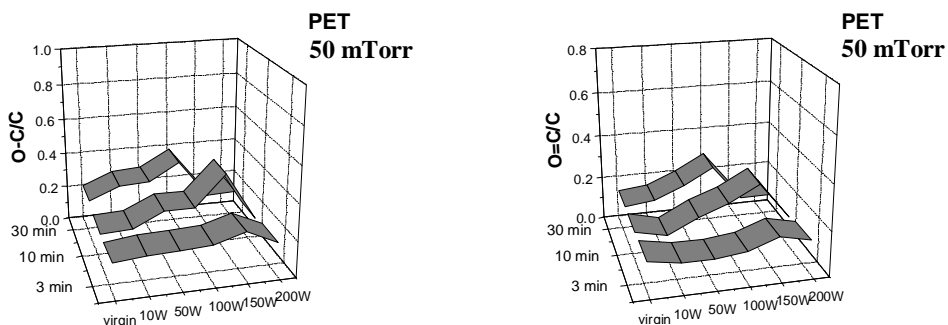

Fig. 5. The O-C/C and O=C/C ratios after plasma treatment at 50 mtorr.

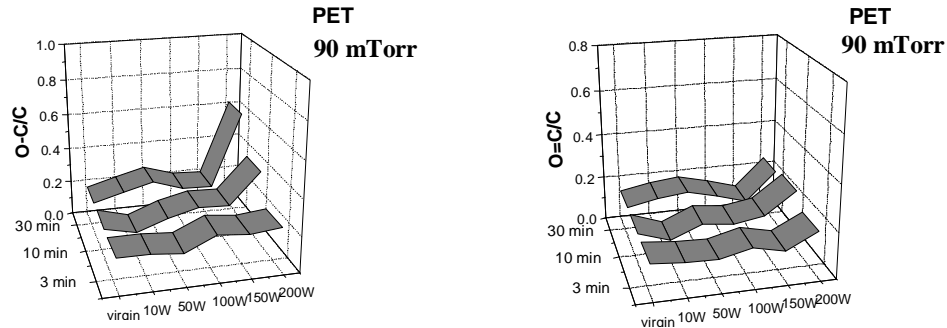

Fig. 6. The O-C/C and O=C/C ratios after plasma treatment at 90 mTorr

One day after the plasma treatment, the contact angle of water to PET was changed from 76° to 42° . Contact angles are closely related to surface free energy. We also measured the change of surface energy due to the formation of the hydrophylic groups by using two polar liquids, distilled water and formamide. As it is shown in Fig. 7, plasma treatment for PET increases mainly the polar force but not too much the dispersion force. In a polymer, the increase of the polar force is known to be mainly due to the formation of polar groups such as $-(O-C)-$, $-(O=C)-$ and $-O-(O=C)-$. From the results, the large decrease of contact angle can be explained by means of dominant increase of the polar force of the surface free energy of the modified polymers [3].

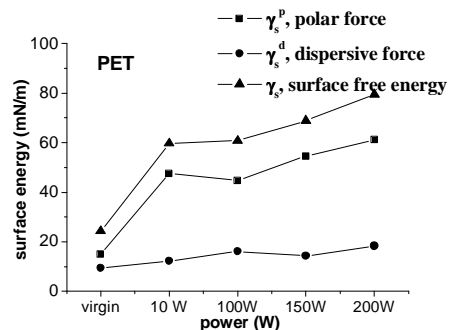

Fig. 7. Surface energy variation versus rf power.

In order to examine the dependence of contact angle and surface free energy on surface roughness, AFM analysis was carried out (Fig. 8). Increasing the rf power and the treatment time it was found an increasing of the surface roughness.

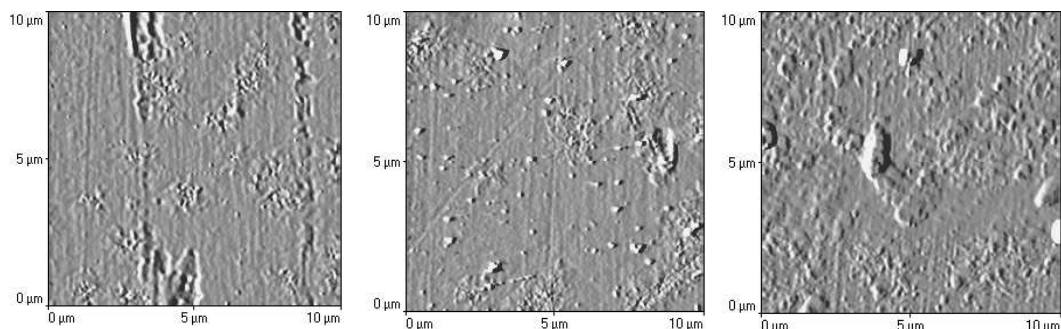

Fig. 8. AFM Images for PET surface before and after the plasma treatment: a) untreated; b) 30 mTorr, 100 W; c) 30 mTorr, 150 W.

Many important applications of polymers require that they adhere well to other materials. Adhesion is a manifestation of the attractive forces that exist in all atoms and fall into two broad categories: dispersive component and polar component.

Therefore it can be expected that the increased surface energy of the modified polymers show an improvement of adhesion between modified polymers and the coating material, in our case the Si layer. Fig. 9 shows the load test results for the untreated and respectively modified polymers.

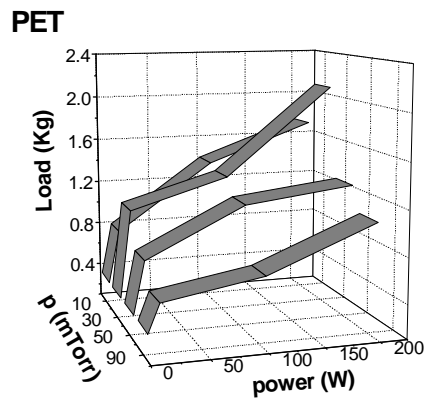

Fig. 9. Load test results for PET.

The load test was proved to be effective in Si removing by XPS analysis of the polymer surface after the test (Table 1).

Table 1. XPS results on the polymer surface after the peel test.

TOA (°)	C1s (%)	O1s (%)	Si2p (%)
70	75.75	24.21	-
40	73.52	26.47	-
0	77.04	22.96	-

4. Conclusion

It was proven that the previously plasma etching has lead to an improvement of the adhesion between the polymer surface and the Si layer. At lower pressures, mainly at 30 mtorr, was found the best quality of adhesion. This fact is confirmed by the surface energy data. The very effective formation of polar groups such as $-(O-C)-$, $-(O=C)-$ and $-O-(O=C)-$, in this pressure range, leads to an increase of the polar force of the surface free energy of the modified polymers. The surface energy increasing of the modified polymers show an improvement of adhesion between modified polymers and the Si layer.

For all range of pressures, rf power values increasing leads to a better quality of adhesion.

References

- [1] N. D. Young, G. Harkin, R. M. Bunn, D. J. McCulloch, IEEE Trans. Electron. Dev. **11**, 1930 (1996).
- [2] I. A. Rusu, G. Popa, J. L. Sullivan, J. of Phys. D: Appl. Phys. **35**, 2808 - 2814 (2002).
- [3] D. K. Owen, R. C. Wendt, J. Appl. Polymer Sci. **13**, 1741 (1969).
- [4] V. M. De Cupere, P. G. Rouxhet, Surface Science **491**, 395 (2001).
- [5] M. Gheorghiu, I. Rusu, G. Popa, Vacuum **47**(9), 1093 (1996).
- [6] G. Marletta, S. Pignataro, A. Toth, I. Bertoti, T. Szekely, B. Keszler, Macromolecules **24**, 99 (1991).